



## STM-103STK development board

## Users Manual

Rev.A, April 2008

Copyright(c) 2008, OLIMEX Ltd, All rights reserved

## INTRODUCTION:

The ARM Cortex-M3 processor is the latest generation of ARM processors for embedded systems. It has been developed to provide a low-cost platform that meets the needs of MCU implementation, with a reduced pin count and low-power consumption, while delivering outstanding computational performance and an advanced system response to interrupts. The ARM Cortex-M3 32-bit RISC processor features exceptional code-efficiency, delivering the high-performance expected from an ARM core in the memory size usually associated with 8- and 16-bit devices.

The STM32F103 Performance Line family has an embedded ARM core and is therefore compatible with all ARM tools and software. It combines the high performance ARM Cortex-M3 CPU with an extensive range of peripheral functions and enhanced I/O capabilities.

**STM32-103STK** is starter-kit board which allow you to explore the complete features of the new ARM Cortex M3 STM32F103RBT6 microcontrollers produced by ST Microelectronics Inc. It have NOKIA 3310 BW 84x48 LCD, buttons, SD-MMC card, 3-axis digital accelerometer, 2.4Ghz RF transceiver, Audio Input and Output, the power supply is made from single 1.5V AA cell battery.

Some applications are USB Mass Storage device, Audio class device, HID mouse device, CDC Virtual com port device, USB Wireless RF link. The UXT connector allow access to all other UEXT modules produced by OLIMEX like MOD-MP3, MOD-NRF24LR, MOD-NOKIA6610 etc to be connected easily. In the prototype area customer can solder his own custom circuits and to interface them to USB, CAN, RS232 etc.

## BOARD FEATURES:

- MCU: STM32F103RBT6 ARM 32 bit CORTEX M3™ with 128K Bytes Program Flash, 20K Bytes RAM, USB, CAN, x2 I2C, x2 ADC 12 bit, x3 UART, x2 SPI, x3 TIMERS, up to 72Mhz operation
- standard JTAG connector with ARM 2x10 pin layout for programming/debugging with ARM-JTAG
- USB mini connector
- LCD NOKIA 3310 BW 84x48 pixels
- 1.5V battery connector with step-up converter
- 3-axis accelerometer
- SD-MMC card
- 2.4 Ghz transceiver with Nordic nRF24L01
- Audio input
- Audio output
- user buttons x2
- Joystick with 4 directions and push action
- UEXT connector for other Olimex's modules connection like MOD-MP3, etc.
- RESET button
- status LED
- 8 Mhz crystal oscillator
- 32768 Hz crystal and RTC backup battery connector
- extension headers for all uC ports
- PCB: FR-4, 1.5 mm (0,062"), soldermask, silkscreen component print
- Dimensions: 90 x 65mm (3.5 x 2.5")

## **ELECTROSTATIC WARNING:**

The **STM32-103STK** board is shipped in protective anti-static packaging. The board must not be subject to high electrostatic potentials. General practice for working with static sensitive devices should be applied when working with this board.

## **BOARD USE REQUIREMENTS:**

**Cables:** 1.8 meter A-to-miniUSB cable to connect to USB host.

**Hardware:** ARM-JTAG, ARM-USB-OCD, ARM-USB-TINY or other ARM JTAG compatible tool

**Software:** ARM C compiler and debugger software, the possible options are:

- free open source platform: GNU C compiler + OpenOCD and Eclipse (support all low cost Olimex JTAG debuggers)
- commercial solution EW-ARM from IAR Systems AB, require expensive J-LINK debugger
- CrossWorks from Rowley (supports all Olimex low cost JTAG debuggers).

BOARD LAYOUT:

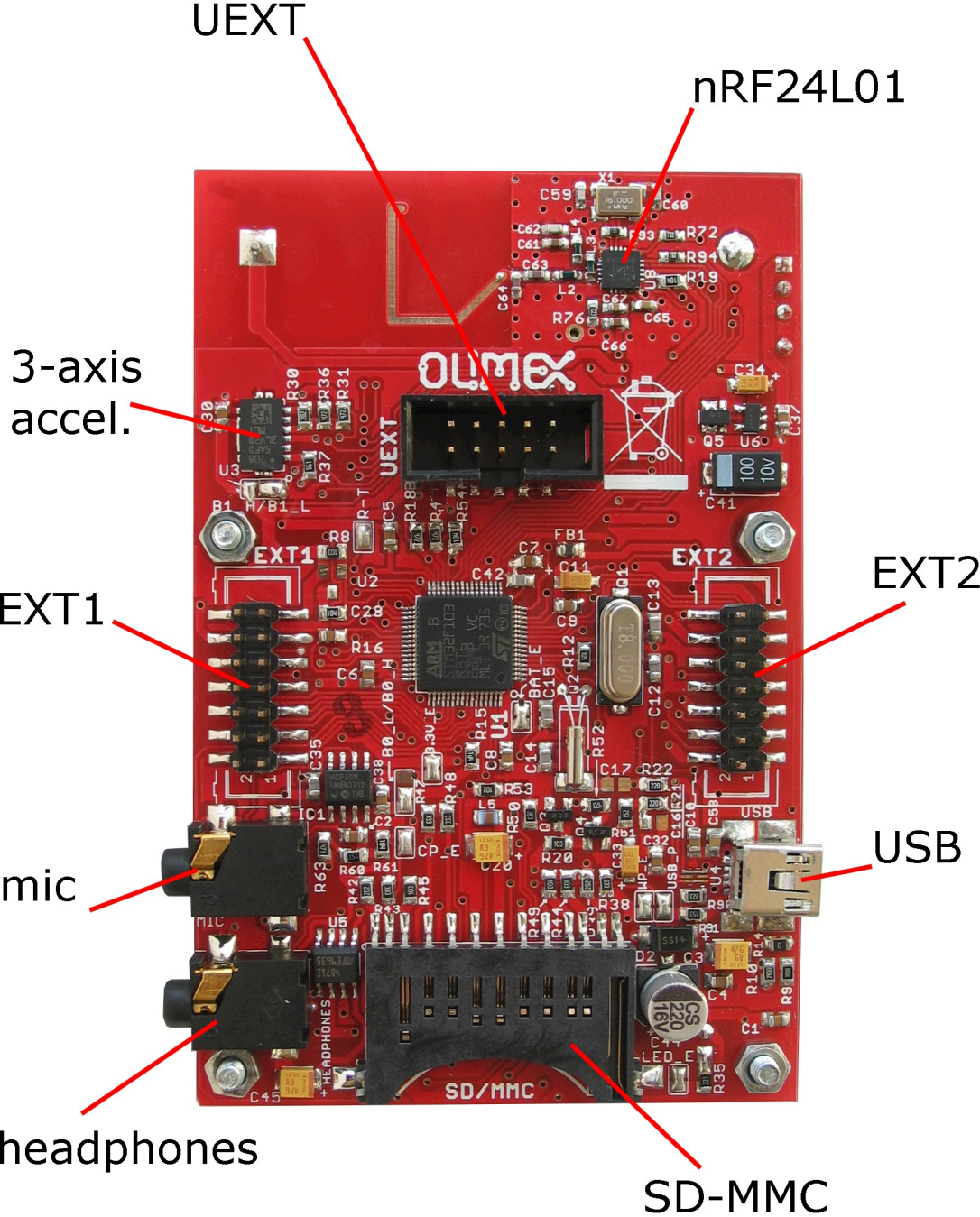

# SCHEMATIC:

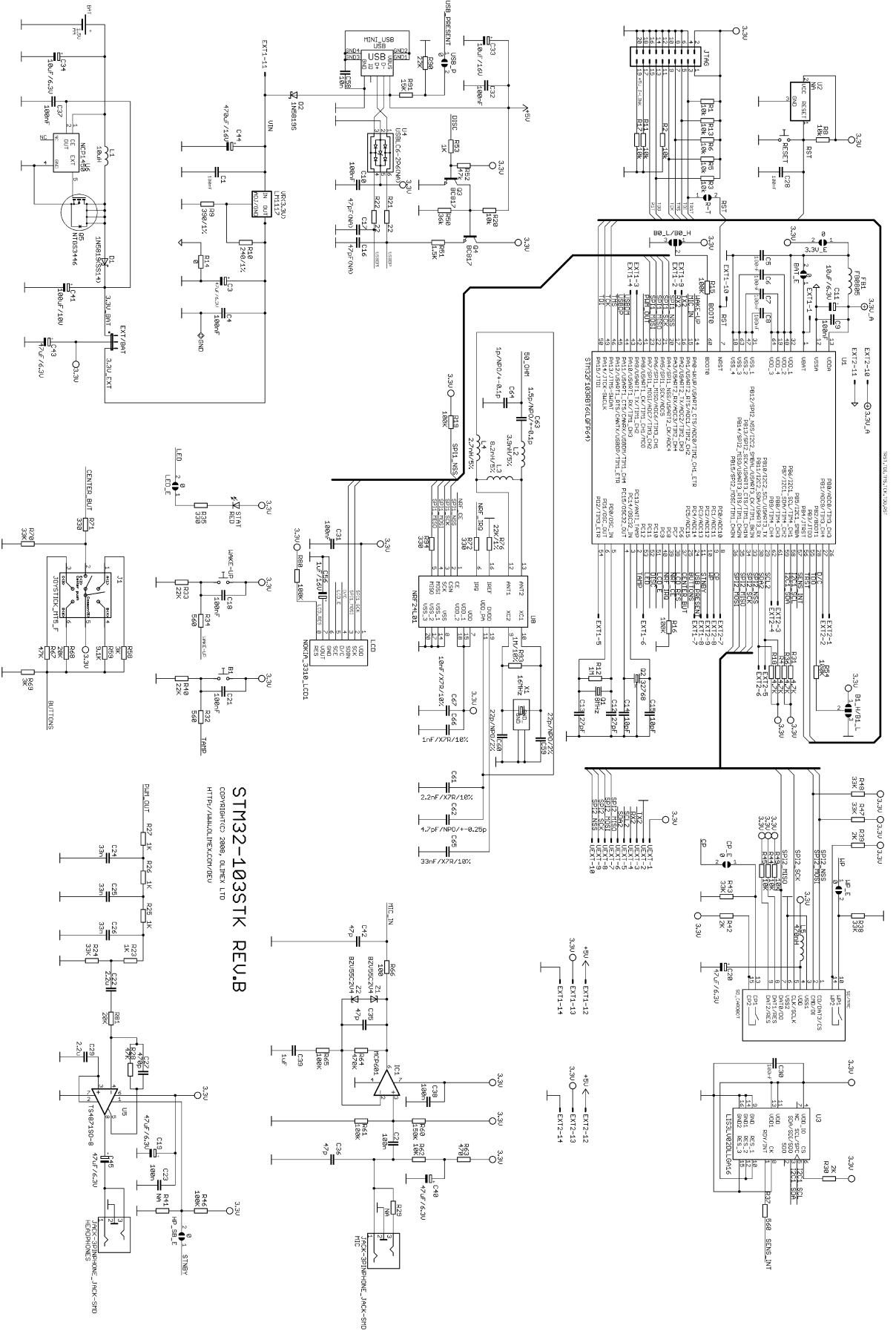

**STM32-103STK REV.B**  
 CPMEDIA/CPIC 2006, QLMEX LTD  
 HTTP://WWW.QLMEX.COM/DEU

## PROCESSOR FEATURES:

**STM-103STK** board use ARM 32-bit Cortex™-M3 CPU **STM32F103RBT6** from ST Microelectronics with these features:

- CPU clock up to 72Mhz
- FLASH 128KB
- RAM 20KB
- DMA x7 channels
- RTC
- WDT
- Timers x3+1
- SPI x2
- I2C x2
- USART x3
- USB x1
- CAN x1 (multiplexed with USB so both can't be used in same time)
- GPIO up to 51 (multiplexed with peripherals)
- 2 ADC 12-bit
- operating voltage 2.0-3.6V
- temperature -40C +85C

## RS232:

STM32F103RBT6 have 3 USARTs which are available on the extension headers. One of them can operate up to 4.5 Mbit/s, the other two up to 2.25 Mbit/s. They provide hardware management of the CTS and RTS signals, IrDA SIR ENDEC support, are ISO 7816 compliant and have LIN Master/Slave capability.

All USART interfaces can be served by the DMA controller.

## SPI:

STM32F103RBT6 have 2 SPIs which able to communicate up to 18 Mbits/s in slave and master modes in fullduplex and simplex communication modes. The 3-bit prescaler gives 8 master mode frequencies and the frame is configurable from 8-bit to 16-bit. The hardware CRC generation/verification supports basic SD Card/MMC modes.

Both SPIs can be served by the DMA controller.

## I2C:

STM32F103RBT6 have two I<sup>2</sup>C bus interfaces which can operate in multi-master and slave modes. They can support standard and fast modes. They support dual slave addressing (7-bit only) and both 7/10-bit addressing in master mode. A hardware CRC generation/verification is embedded.

They can be served by DMA and they support SM Bus 2.0/PM Bus.

## **CAN:**

The STM32F103RBT6 CAN is compliant with specifications 2.0A and B (active) with a bit rate up to 1 Mbit/s. It can receive and transmit standard frames with 11-bit identifiers as well as extended frames with 29-bit identifiers. It has three transmit mailboxes, two receive FIFOs with 3 stages and 14 scalable filter banks.

The CAN and USB share same pins PA11 and PA12, so you can't use both CAN and USB on same time.

## **USB:**

The STM32F103RBT6 embeds a USB device peripheral compatible with the USB Full-speed 12 Mbs. The USB interface implements a full speed (12 Mbit/s) function interface. It has software configurable endpoint setting and suspend/resume support. The dedicated 48 MHz clock source is generated from the internal main PLL.

The CAN and USB share same pins PA11 and PA12, so you can't use both CAN and USB on same time.

## **ADC:**

STM32F103RBT6 have two 12-bit Analog to Digital Converters which share up to 16 external channels, performing conversions in singleshot or scan modes. In scan mode, automatic conversion is performed on a selected group of analog inputs.

Additional logic functions embedded in the ADC interface allow:

- Simultaneous sample and hold
- Interleaved sample and hold
- Single shunt

The ADC can be served by the DMA controller.

An analog watchdog feature allows very precise monitoring of the converted voltage of one, some or all selected channels. An interrupt is generated when the converted voltage is outside the programmed thresholds. The events generated by the standard timers (TIMx) and the Advanced Control timer (TIM1) can be internally connected to the ADC start trigger, injection trigger, and DMA trigger respectively, to allow the application to synchronize A/D conversion and timers.

# BLOCK DIAGRAM:

STM32F103xx performance line block diagram

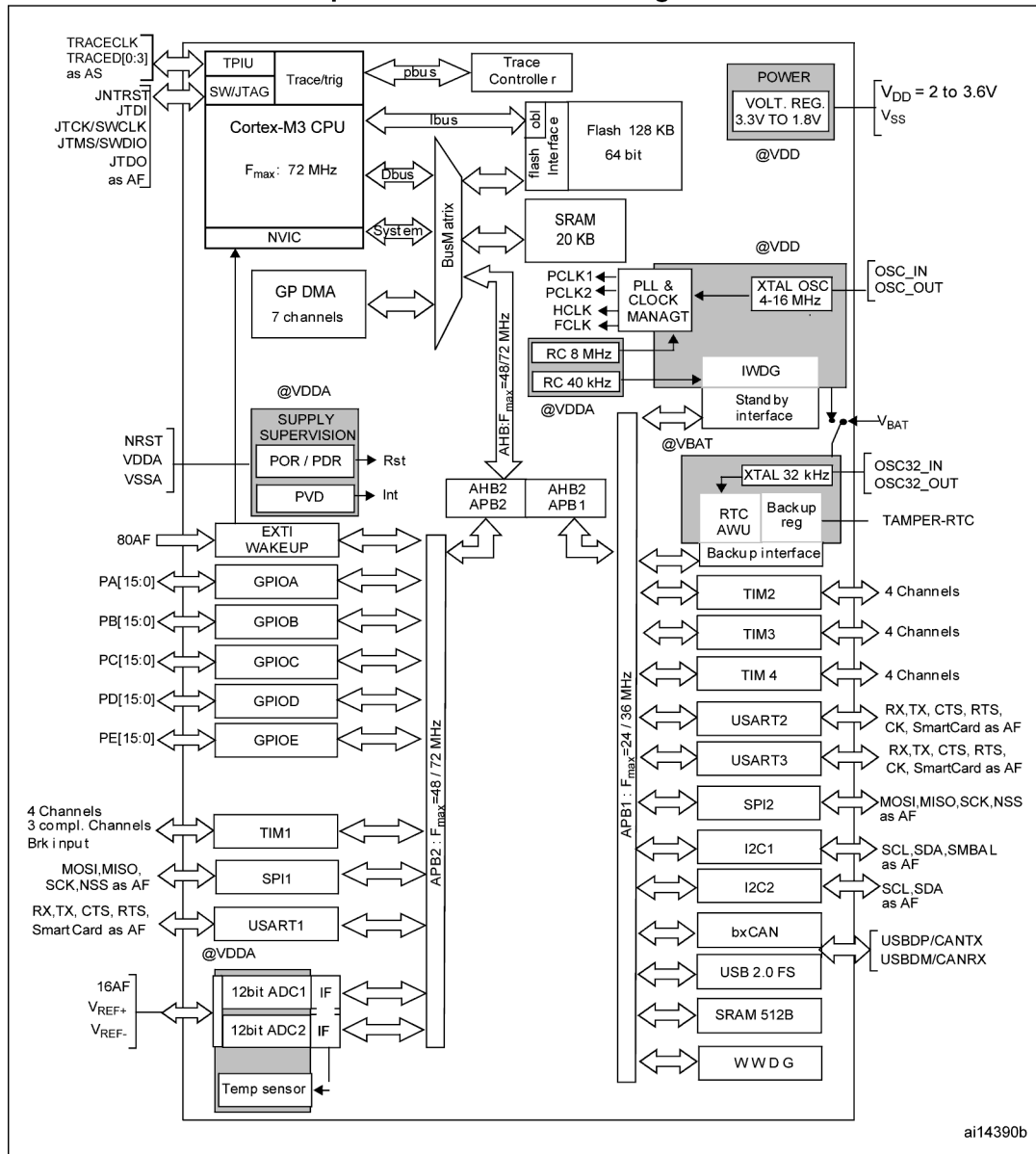

ai14390b

1. T<sub>A</sub> = -40 °C to +105 °C (junction temperature up to 125 °C).
2. AF = alternate function on I/O port pin.



# MEMORY MAP:

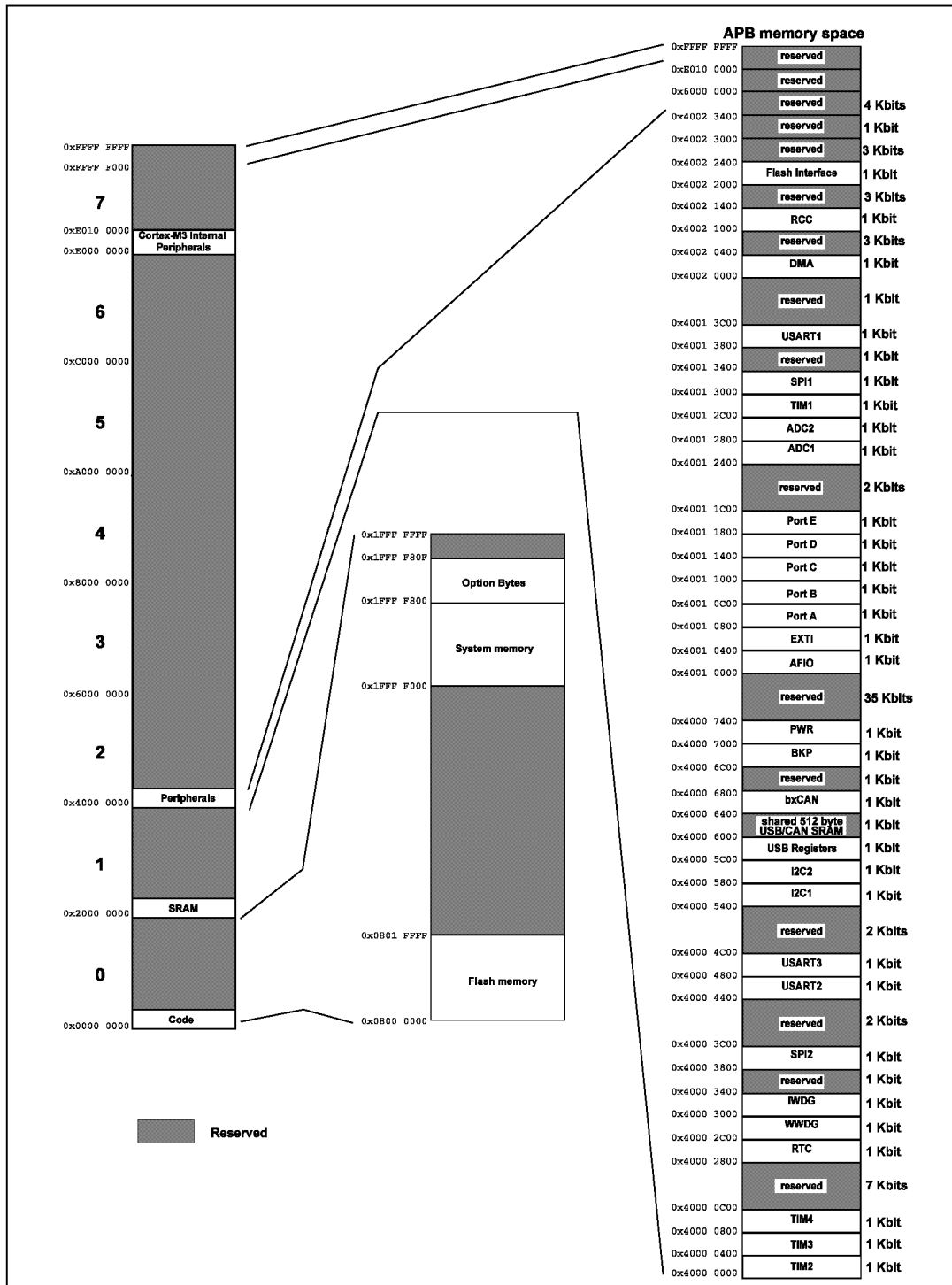

## POWER SUPPLY CIRCUIT:

**STM32-103STK** can take power from these sources:

- 1.5V battery with DC/DC step up converter
- Vin signal on EXT1-11 pin.
- JTAG pin.1 or 2

The board power consumption is: about 30 mA when powered from the USB port and 130mA when powered from 1.5V battery with all peripherals and MCU running at full speed, there are different power saving modes which may put STM32F103RBT6 in power sleep mode and in these modes the consumption of the MCU is only few microamps.

## RESET CIRCUIT:

**STM32-103STK** reset circuit is made with RC group R8 - 10K and C28-100nF.

Although on the schematic is made provision for external reset IC such is not necessary as STM32 have build-in brown out detector. Manual reset is possible by the RESET button.

## CLOCK CIRCUIT:

Quartz crystal 8Mhz is connected to STM32F103RBT6. Internal PLL circuit can multiply this frequency up to 72Mhz.

32.768 KHz quartz crystal is connected to STM32F103RBT6 for it's internal Real Time Clock.

## JUMPER DESCRIPTION:

**EXT/BAT** 3 pin, power supply select jumper.

**EXT** position  **EXT/BAT**

Allow power supply from mini-USB connector or EXT1(pin11). The voltage supplied to EXT1(pin 11) must be between 5VDC and 9VDC.

**BAT** position  **EXT/BAT**

Allow power supply from 1.5V AA (R6), no charge battery, plugged in the BAT connector.

**R-T** Connects JTAG TRST signal to STM32F103RBT6 RESET  
Default state closed (shorted)

**BAT\_E** Connects 3.3V to STM32F103RBT6 Vbat pin.1  
Default state closed (shorten), Vbat signal is also available to EXT1 (pin 1) connector, so if you want to connect external backup battery to the STM32F103RBT6 this jumper should be opened (unshorted) and the external battery to be connected to EXT1 (pin 1) connector(see connector description for EXT1 connector pining.).VBAT accept 2 - 3.6V.

**USBP-E** Connects USB power supply to STM32F103RBT6 pin 24 PC4/ADC14 and allow to detect if the board is connected to USB host.

Default state closed (shorten)

**LED-E** Connects STATUS LED to STM32F103RBT6 pin 53 PC12

Default state closed (shorten)

**BOOT0, BOOT1** boot sequence select

B1\_H/B1\_L (Boot1\_High/Boot1\_Low)

B0\_L/B0\_H (Boot0\_Low /Boot0\_High)

B1\_H/B1\_L

Default position: Boot1 is log. 0



B0\_L/B0\_H

Boot0 is log. 0



Boot mode selection pins		Boot mode	Aliasing
BOOT1	BOOT0		
x	0	User Flash memory	User Flash memory is selected as boot space
0	1	SystemMemory	SystemMemory is selected as boot space
1	1	Embedded SRAM	Embedded SRAM is selected as boot space

**CP\_E** Card Present Enable – Allow PC1(pin 9) to detect Multi Media Card present in socket. Log. 1 of PC1 – MMC present. Log.0 of PC1 – Card absent.

Default state closed (shorten)

**WP\_E** Write Protect Enable – Allow PC2(pin 10) to detect write protected state of Multi Media Card. Log. 1 of PC2 – MMC no write protected . Log.0 of PC2 – MMC is write protected.

Default state closed (shorten)

**3.3V\_E** Connect 3.3V regulated voltage to STM32F103RBT6 power pins. **3.3V\_E** jumper is used if you need to measure current consumption of the microcontroller.

Default state closed (shorten)

## INPUT/OUTPUT:

**JOYSTICK** this is 4 directions plus center button, in the schematic the joystick four directions switches are connected through resistors with different values to PC5/ADC15 , the center button is connected to PC6;

**BUTTON B1** Left button connected to PC13/TAMPER port;

**BUTTON B2** Right button connected to PA0/WAKE-UP port;

**LCD** NOKIA3310 84x48 pixel black and white LCD to SPI1 port;

**ACCELEROMETER** 3-axis accelerometer connected to I2C1 port;

**Audio In** microphone with pre-amplifier connected to PA1 ADC;

**Audio Out** audio amplifier connected to PA8 PWM output;

**SD-MMC** card connected to SPI2;

**nRF24L01** connected to SPI1;

Power supply red LED with name **PWR** – indicates that 3.3V power supply is applied.

## CONNECTOR DESCRIPTION:

### JTAG:

#### JTAG CONNECTOR PIN DESCRIPTIONS

Pin #	Signal Name	Pin #	Signal Name
1	TVCC 3.3V	2	TVCC 3.3V
3	TRST	4	GND
5	TDI	6	GND
7	TMS	8	GND
9	TCK	10	GND
11	NC	12	GND
13	TDO	14	GND
15	RST	16	GND
17	NC	18	GND
19	NC	20	GND

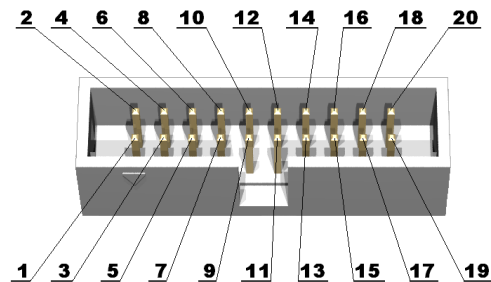

TMS	Input	<b>Test Mode Select.</b> The TMS pin selects the next state in the TAP state machine.
TCK	Input	<b>Test Clock.</b> This allows shifting of the data in, on the TMS and TDI pins. It is a positive edgetriggered clock with the TMS and TCK signals that define the internal state of the device.
TDI	Input	<b>Test Data In.</b> This is the serial data input for the shift register.
TDO	Output	<b>Test Data Output.</b> This is the serial data output from the shift register. Data is shifted out of the device on the negative edge of the TCK signal.
TRST	Input	<b>Test Reset.</b> The TRST pin can be used to reset the test logic within the EmbeddedICE logic.

## EXT1

Pin #	Signal Name	Pin #	Signal Name
1	VBAT	2	PA3/USART2_RX/ ADC3/TIM2_CH4
3	PA9/USART1_TX/ TIM1_CH2	4	PA10/USART1_RX/ TIM1_CH2
5	RD0/OSC_IN	6	PC12/LED
7	PC4/ADC14/ USB_PRESENT	8	PC3/ADC13/ STNBY
9	PA2/USART2_TX/ ADC2/ITIM2_CH3	10	NRST
11	VIN	12	+5.0V
13	3.3V	14	GND

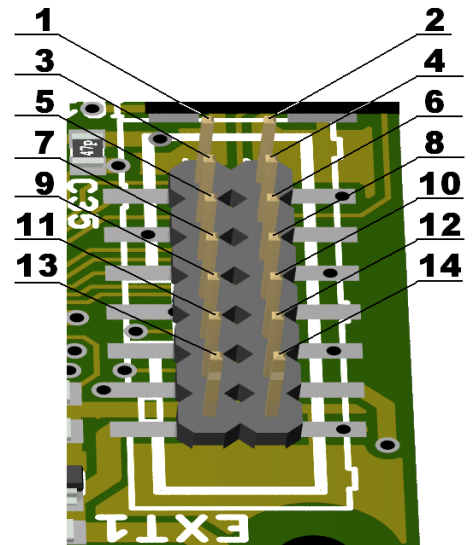

## EXT2

Pin #	Signal Name	Pin #	Signal Name
1	PB0/ADC8/TIM3_CH3	2	PB1/ADC9/TIM3_CH4
3	PB8/TIM4_CH3	4	PB9/TIM4_CH4
5	SCL2	6	SDA2
7	PC0/ADC10	8	CP
9	WP	10	3.3V_A
11	AGND	12	+5.0
13	3.3V	14	GND

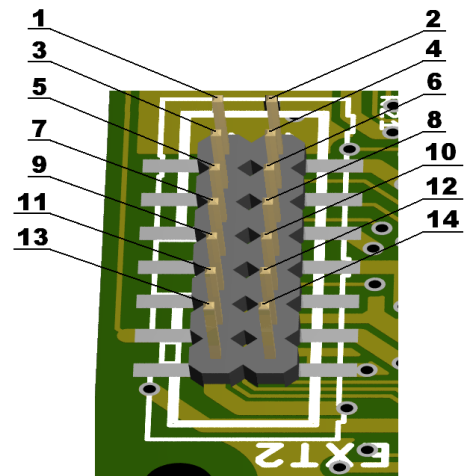

## UEXT

Pin #	Signal Name	Pin #	Signal Name
1	VCC 3.3V	2	GND
3	TX2	4	RX2
5	SCL2	6	SDA2
7	SPI2_MISO	8	SPI2_MOSI
9	SPI2_SCK	10	SPI2_NSS

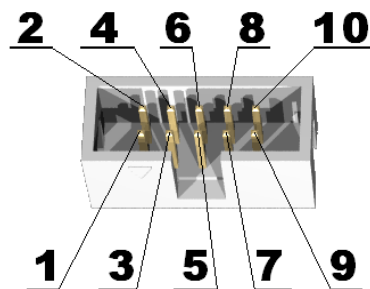

## SD-MMC

Pin #	Signal Name	Pin #	Signal Name
1	SPI2_NSS	2	SPI2_MOSI
3	GND	4	VCC
5	SPI2_SCK	6	GND
7	SPI2_MISO	8	10K to 3.3V
9	10K to 3.3V	10	WP_E
11	to pin 14	12	to pin 15
13	CP_E	14	2K to 3.3V
15	2K to 3.3V		

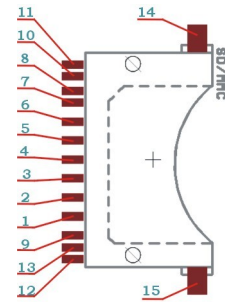

## USB

Pin #	Signal Name
1	VBUS
2	USBDM
3	USBDP
4	NC
5	GND

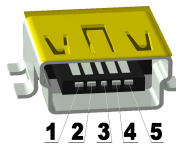

## AVAILABLE DEMO SOFTWARE:

- USB mouse with the 3-axis accelerometer
- USB class Audio device
- USB mass storage
- USB Virtual com port
- USB RF Virtual com port bridge
- Ball game with accelerometer
- OpenOCD demo project

## ORDER CODE:

**STM32-103STK - assembled and tested (no kit, no soldering required)**

**How to order?**

**You can order to us directly or by any of our distributors.**

**Check our web [www.olimex.com/dev](http://www.olimex.com/dev) for more info.**



All boards produced by Olimex are ROHS compliant

### **Revision history:**

REV.A - create April 2008

**Disclaimer:**

© 2008 Olimex Ltd. All rights reserved. Olimex®, logo and combinations thereof, are registered trademarks of Olimex Ltd. Other terms and product names may be trademarks of others.

The information in this document is provided in connection with Olimex products. No license, express or implied or otherwise, to any intellectual property right is granted by this document or in connection with the sale of Olimex products.

Neither the whole nor any part of the information contained in or the product described in this document may be adapted or reproduced in any material from except with the prior written permission of the copyright holder.

The product described in this document is subject to continuous development and improvements. All particulars of the product and its use contained in this document are given by OLIMEX in good faith. However all warranties implied or expressed including but not limited to implied warranties of merchantability or fitness for purpose are excluded.

This document is intended only to assist the reader in the use of the product. OLIMEX Ltd. shall not be liable for any loss or damage arising from the use of any information in this document or any error or omission in such information or any incorrect use of the product.